

5. Diagnostics

If the red light on the front of the bill validator is ON insert bill and remove it after the red light goes OFF. Count the number of red flashes and compare with the diagnostic chart below.

#	Description	#	Description
1	Cassette is removed from bill acceptor	7	Failure of magnetic sensors
2	Stacking motor does not rotate	8	Transport motor does not move
3	Cassette is full	9	Speed of transport motor is too high
4	Mechanical jam in the cassette	10	Transport motor electrical overload
5	Stacking motor electrical overload	11	Bill pathway security latch is open
6	Failure of optical sensors	12	Banknote is in the entry slot of the cassette and credit's not issued

Notes:

- If the bill was inserted but the red light on the front of the bill acceptor did not go OFF there is a failure in communication.
- When diagnostics is completed the red light becomes steady again. Do not consider it as a flash and do not count it.

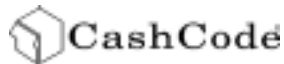

CashCode Company Inc.
553 Basaltic Rd. Concord, Ontario Canada. L4K 4W8
TEL: (905) 303-8874 (800)-584-2633
FAX: (905) 303-8875 (800)-593-2633

© 1998-1999, CashCode Co. Inc PT# UG_07A4ML(H) Rev.E1 07/99

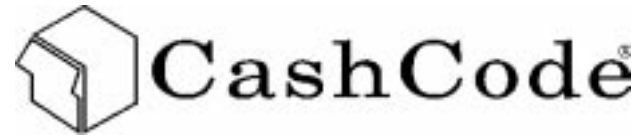

12V Bill Validator
with Stacker
User's Guide

US4-CSB-ST07-ML

Low height bezel

US4-CSB-ST07-MH

High height bezel

Model AMZ-USA-PLUS-UNV
for CashCode® Serial Interfaces

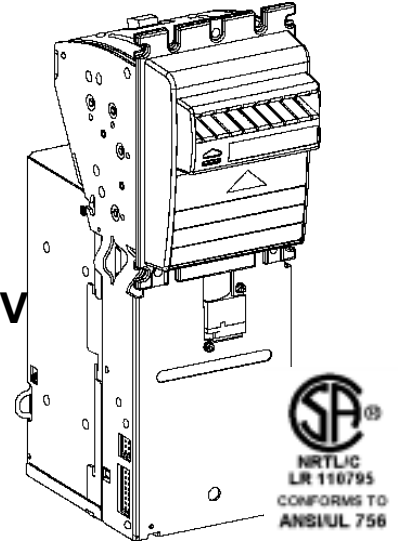

1. General Specifications:

CURRENCY: \$1, \$5, \$10, \$20 USA Dollars

INTERFACES: Pulse Interface
CashCode Serial Interface (MEI compatible)

ELECTRICAL SPECIFICATION:

Operating Voltage	Maximum Operating Current	Maximum Overload Current (t<2.2 sec)
10...14 V DC	0.85 A DC	2.5 A DC

Use only current limiting CSA or UL recognized CLASS 2 Power Supply.

OPERATING TEMPERATURE: -0 to +50 degrees Celsius

TOTAL WEIGHT WITHOUT CASSETTE < 1.2 kg

ENCLOSURE: Bill Validator Part #:US4-CSB-ST07-MH(L)
User's Guide: Part # OPT-UG-07A4MH(L)
Accessories: Power Harness, Part # AMZ-XXX-12-06
Jumper Connector, Part # AMZ-XXX-PC-18
Front Label, Part # AMZ-LB-US4

OPTIONAL ACCESSORIES:

Serial Interface Test adapter; Part # OPT-XXX-CS

2. DIP switches layout:

To access Switches remove the cover

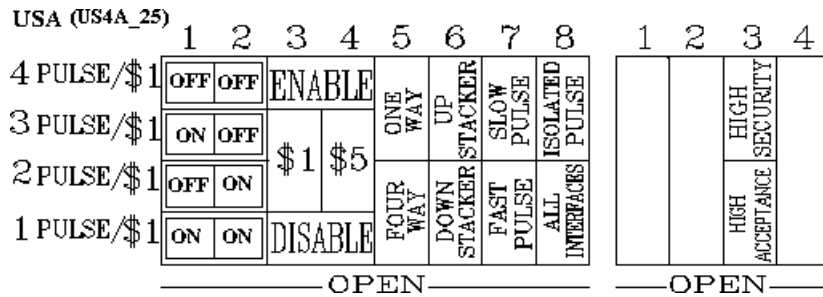

3. Connector pinout

6 pin connector pinout

Pin	DESCRIPTION	WIRE COLOUR
1	+12V DC	Yellow
2	GND	Black
3	Pulse Output (NO)	Green
4	Common	Blue
5	Inhibit Line (+)	White
6	Inhibit Line (-)	Brown

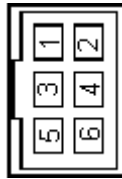

Mating connector:

MOLEX: 15-04-5064 -1pcs; 50-57-9303 -2pcs; 16-02-0096 -6pcs;

18 pin connector pinout

Pin	DESCRIPTION	Pin	DESCRIPTION
1	Credit Pulse	10	Out of service
2	Interrupt	11	Reserved
3	Serial/Pulse Select	12	Accept Enable
4	Common	13	LED Power Source
5	Serial Data Output	14	Send
6	Reserved	15	Reserved
7	Reserved	16	Escrow
8	Reserved	17	Reserved
9	Reserved	18	Reserved

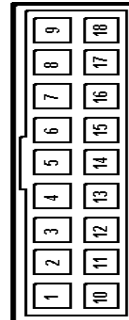

Mating connector:

AMP: 102398-7 - 1pcs; 102681-4 - 1pcs; 102536-7 - 1pcs;

4. Interfaces

4.1. Pulse Interface Specifications:

Fast Pulses: Pulse 50 ms - Pause 50 ms
 Slow Pulses: Pulse 50 ms - Pause 300 ms
 Pulse modes: 1pulse; 2pulses; 3pulses; 4pulses /\$1
 Features: Pulse accumulation mode and Inhibit line
 Isolated and Non-isolated Pulse output

ISOLATED PULSE Interface (INHIBIT LINE feature disabled)

1. Set DIP Switches 8(of 8)-ON position.
2. Use 6 Pin Power Harness PT# AMZ-XXX-12-06. The Pulse Output is a bounce free N/O contact and polarity of the output wiring does not matter.

ISOLATED PULSE Interface (INHIBIT LINE feature enabled)

1. Set DIP Switches 8 (of 8)-OFF position.
2. Apply Jumper Connector PT# AMZ-XXX-PUL-18 to 18 Pin connector of the bill acceptor.
3. Connect the bill acceptor to the machine controller via 6 Pin Power Harness PT# AMZ-XXX-12-06. The Pulse Output is a bounce free N/O contact and the polarity of the output connection does not matter.
4. Connection to the INHIBIT LINE depends on the machine controller lockout circuitry. See figure below:

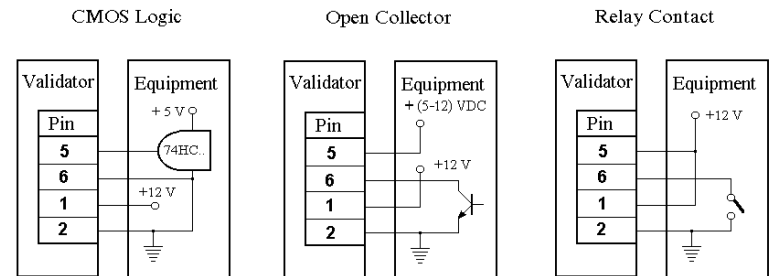

4.2. CashCode® SERIAL Interface

1. Set DIP Switch 8 (of 8) - OFF position.
 2. Provide the power to the bill acceptor via 6 pin Power Harness .
 3. Connect the bill acceptor to the machine controller via 18 Pin Serial Harness
- CashCode® Serial Interface (MEI compatible) Serial messages:

81h	82h	83h	84h	85h	86h	87h
\$1	N/A	\$5	\$10	\$20	N/A	N/A
89h	8Ah	8Bh	8Ch	8Dh	8Eh	8Fh
VEND	N/A	RETURN	FAILURE	BOX FULL	BOX ATTACHED	BOX REMOVED