

5. Diagnostics

If the red light on the front of the bill validator is ON insert bill and remove it after the red light goes OFF. Count the number of red flashes and compare with the diagnostic chart below.

#	Description	#	Description
1	N/A	7	Failure of magnetic sensors
2	N/A	8	Transport motor does not move
3	N/A	9	Speed of transport motor is too high
4	N/A	10	Transport motor electrical overload
5	N/A	11	Bill pathway security latch is open
6	Failure of optical sensors	12	Banknote is in the entry slot of the cassette and credit's not issued

Notes:

- If the bill was inserted but the red light on the front of the bill validator did not go OFF there is a failure in communication.
- When diagnostics is completed the red light becomes steady again. Do not consider it as a flash and do not count it.

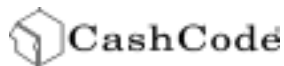

CashCode Company Inc.
553 Basaltic Rd. Concord, Ontario Canada. L4K 4W8
TEL: (905) 303-8874 (800)-584-2633
FAX: (905) 303-8875 (800)-593-2633

© 1998-1999, CashCode Co. Inc PT# UG_BV15XA4 Rev.E1 07/99

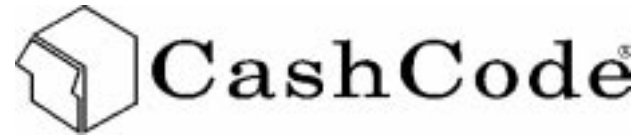

12V Stackerless Bill Validator User's Guide

CA4-CS0-BV15

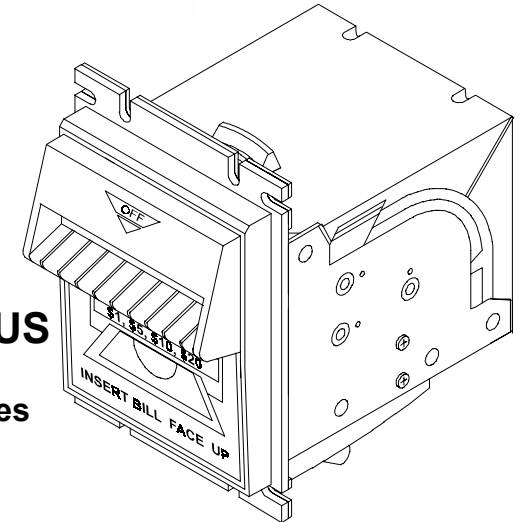

Model AMZ-CND-PLUS for Pulse and CashCode® Serial Interfaces

1. General Specifications:

CURRENCY: \$2, \$5, \$10, \$20 Canadian Dollars (Can\$)
Notes: Portrait Up direction only
INTERFACES: Pulse Interface
CashCode Serial Interface (MEI compatible)

ELECTRICAL SPECIFICATION:

Operating Voltage	Maximum Operating Current	Maximum Current
12...14 V DC	0.55 A DC	0.6 A DC

Use only current limiting CSA or UL recognized CLASS 2 Power Supply.

OPERATING TEMPERATURE: -0 to +50 degrees Celsius

ENCLOSURE: Bill Validator Part #: CA4-CS0-BV15
User's Guide: Part # OPT-UG-BV15XA4
Accessories: Power Harness, Part # AMZ-XXX-12-06
Jumper Connector, Part # AMZ-XXX-PC-18
Front Label, Part # AMZ-LB-CA4

OPTIONAL ACCESSORIES:

Serial Interface Test adapter; Part # OPT-XXX-CS



2. DIP switches layout:

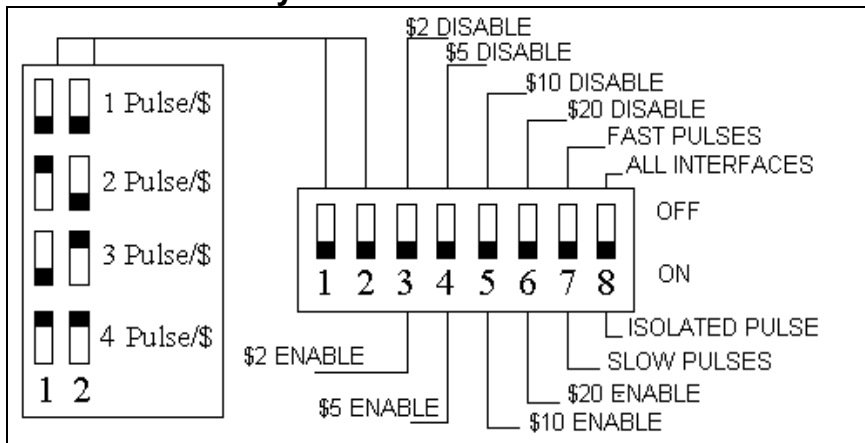

3. Connector pinout

6 pin connector pinout

Pin	DESCRIPTION	WIRE COLOUR
1	+12V DC	Yellow
2	GND	Black
3	Pulse Output (NO)	Green
4	Common	Blue
5	Inhibit Line (+)	White
6	Inhibit Line (-)	Brown

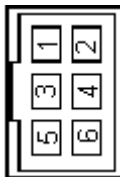

Mating connector:

MOLEX: 15-04-5064 -1pcs; 50-57-9303 -2pcs; 16-02-0096 -6pcs;

18 pin connector pinout

Pin	DESCRIPTION	Pin	DESCRIPTION
1	Credit Pulse	10	Out of service
2	Interrupt	11	Reserved
3	Serial/Pulse Select	12	Accept Enable
4	Common	13	LED Power Source
5	Serial Data Output	14	Send
6	Reserved	15	Reserved
7	Reserved	16	Escrow
8	Reserved	17	Reserved
9	Reserved	18	Reserved

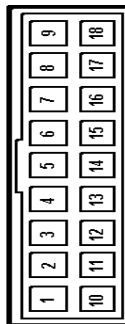

Mating connector:

AMP: 102398-7 - 1pcs; 102681-4 - 1pcs; 102536-7 - 1pcs;

4. Interfaces

4.1. Pulse Interface Specifications:

Fast Pulses: Pulse 50 ms - Pause 50 ms
 Slow Pulses: Pulse 50 ms - Pause 300 ms
 Pulse modes: 1pulse; 2pulses; 3pulses; 4pulses /\$1
 Features: Pulse accumulation mode and Inhibit line
 Isolated and Non-isolated Pulse output

ISOLATED PULSE Interface (INHIBIT LINE feature disabled)

1. Set DIP Switch 8 to ON position.
2. Use 6 Pin Power Harness PT# AMZ-XXX-12-06. The Pulse Output is a bounce free N/O contact and polarity of the output wiring does not matter.

ISOLATED PULSE Interface (INHIBIT LINE feature enabled)

1. Set DIP Switch 8 to OFF position.
2. Apply Jumper Connector PT# AMZ-XXX-PUL-18 to 18 Pin connector of the bill acceptor.
3. Connect the bill acceptor to the machine controller via 6 Pin Power Harness PT# AMZ-XXX-12-06. The Pulse Output is a bounce free N/O contact and the polarity of the output connection does not matter.
4. Connection to the INHIBIT LINE depends on the machine controller lockout circuitry. See figure below:

CMOS Logic

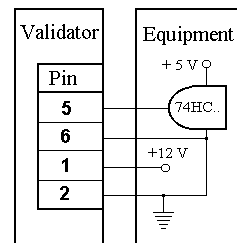

Open Collector

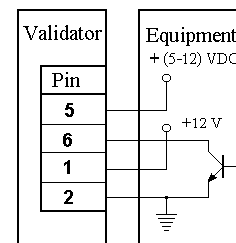

Relay Contact

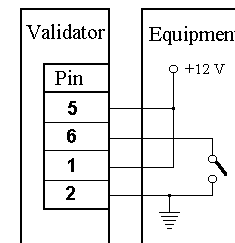

4.2. CashCode® Serial Interface

1. Set DIP Switch 8 to OFF position.
2. Provide the power to the bill acceptor via 6 pin Power Harness .
3. Connect the bill acceptor to the machine controller via 18 Pin Serial Harness CashCode® Serial Interface (MEI compatible) Serial messages:

81h N/A	82h \$2	83h \$5	84h \$10	85h \$20	86h N/A	87h N/A
89h VEND	8Ah N/A	8Bh RETURN	8Ch FAILURE	8Dh N/A	8Eh N/A	8Fh N/A