

SUZOHAPP

Your Solutions Expert
G2E 2015



Your OEM Solutions Expert

Engineered Solutions for Your Gaming Requirements



** For more information please contact your SUZOHAPP Representative*

Toppers

We provide custom engineered solutions from concept to production.



Aristocrat Wheel Toppers

Photo Courtesy of Aristocrat

Multimedia Single and Double Topper



Photo Courtesy of Multimedia Games

Aura Light

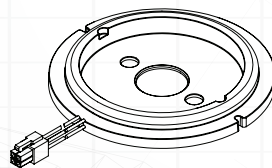
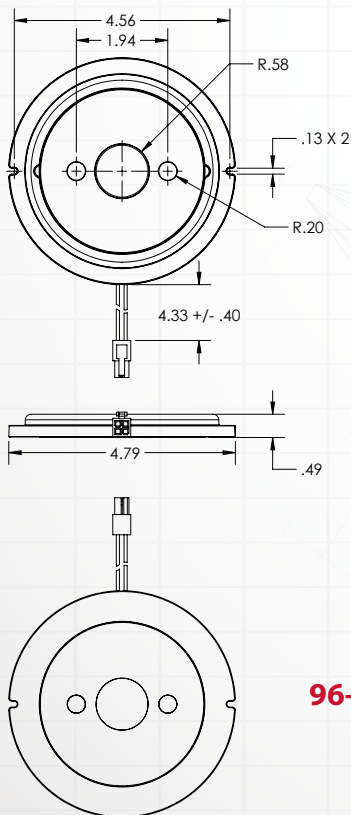

96-1558-00

*** For more information please contact your SUZOHAPP Representative**

Snapshot TFT LCD Button

The Snapshot LCD Button unit is an innovative addition to the SUZOHAPP range of gaming devices, giving the game designer additional tools to enhance the content and player appeal for new gaming machine concepts.

Features:

- Integrated seal protects button LCD circuitry from liquid spills
- Aura accent lighting - provided by single LED
- Aura accent lighting comes in a range of colors
- Option to customize LCD decal surround (Black standard)
- 24 frames per second animation
- Full color 128 x 128 Pixels
- USB interface, controller board controls from 1 to 16 buttons.
- RoHS compliant

Advantages:

- Economical alternative to OLED Buttons
- Individual Buttons allow your choice of placement
- If replacement required, you don't have to replace complete button deck, just the button
- No more printed legends

Display text to enhance game play or multi-function selection

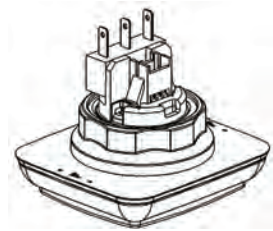
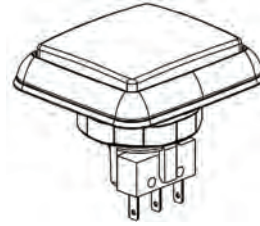

Electronic Specifications:

Controller PCB:	12VDC
Controller Board can drive:	1 to 16 Buttons
Recommend Power Supply for 16 button panel:	12Vdc 2A
Current Average	12VDC 0.8A
Compliance	RoHS Compliant

Button Physical Specifications for Reference Only:

Button Bezel Size with Light Ring:	49.5mm x 44.4mm
Lens Cap size:	38.40mm x 33.40mm
Viewing area of LCD:	27.30mm x 26.30mm
Height above panel to top of Lens Cap:	11.5mm
Height below the button panel to the bottom of switch terminals:	32mm
Panel Cut out size for each button:	22mm x 22mm

Part Number	Description
130-08019-01	LCD Button, 1 White, Chrome, with Cable, without Controller
RS828-E02-01	LCD Button Controller

Compact RGB Handle Mechanism:

- Ultra Low-Profile design allows for external mounting on cabinet and provides increased space on the inside of the cabinet
- Ships as one assembly with handle for easy "Bolt-On" installation
- Easy to remove for improved serviceability
- Ruggedized die cast design to provide long term performance
- RGB Attract Mode on handle mechanism (cover attracts additional attention)
- Pre-Programmed with unique flashing patterns and color combinations
- RGB Illuminated Mechanism ball with 2 multi color LED's that flash, glow or flash light patterns
- Durable ABS plastic cover
- 45 Degree rotation
- Available with Switches or Optics
- 12VDC LEDs & Coil
- Patent Pending Design

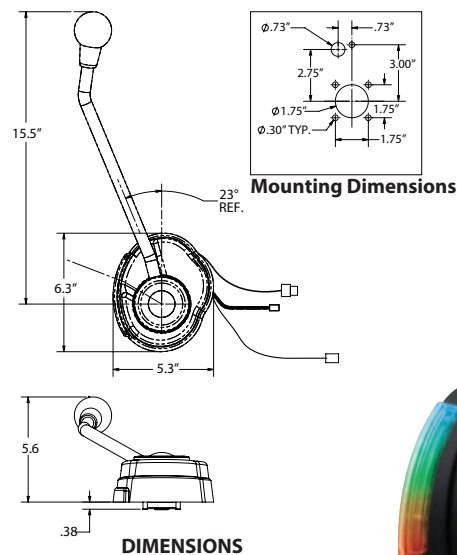

Part Number	Description
RBM-729-F	Compact RGB Handle Mechanism with RGB Ball & Std Black Hub
RBM-729-A1	Compact RGB Handle Mechanism with Black Ball & RGB Effect Hub
RBM-729-A	Compact Handle Mechanism with Black Ball & Std Black Hub
RBM-729-1	Compact RGB Handle Mechanism with No Handle & RGB Effect Hub
RBM-729	Compact Handle Mechanism with No Handle & Std Black Hub

**Dimensioned diagrams are for general reference only
For more information please contact your SUZOHAPP Representative*

ELO Tablet

- Rugged & Connected
- Windows / Intel Architecture
- Integrated MSR, Barcode Reader, Smart Card Reader
- Docking Station

Benefits:

Reliable

- Ruggedized to survive retail environments
- Centralized security and management
- Quality touch from a trusted retail supplier

Integrated

- MSR, Barcode Reader, and Smart Card Reader
- Designed for EMV
- Wi-Fi, Bluetooth, NFC and RFID wireless
- Docking station with battery charging location, Ethernet, 3 x USB, and VGA



Compatible

- Windows / Intel support for your existing applications
- USB connectivity to external peripherals
- Deployable in cloud, thin-client, or client-server environments

Purpose Built

- Mobile Point-of-Service
- Omnichannel Insight
- Endless Aisle



2244L 22" Open-Frame Touchmonitor

Applications:

- Gaming Machines
- Kiosks
- Point-of-information
- Sell-service and ticketing
- Multi-touch performance with "Built for Touch" reliability
- 55% energy savings using LED technology
- Commercial durability
- 3 year standard warranty

I-Series 22-inch Interactive Signage

Benefits:

- In-store interactive touchscreens that attract, engage and educate shoppers at the point of decision
- Leverage existing mobile applications and digital marketing content
- Optimize deployments with cloud-based configuration monitoring and scheduling
- Unlock apps from the app store to integrate them with in-store point of purchase displays
- Guide and influence the buyer's journey rather than running the risk of a crowd sourced decision on the shopper's mobile device
- Perfect for endless-aisle, cross-sell, up-sell, loyalty reward, remote specialist, and other self-serve interactive applications



** For more information on ELO products please contact your SUZOHAPP Representative*

We Are Your Source For Skill-Based Gaming Components



3" Diameter White High Lip Trackball



- Updated case design with high lip around trackball for use on updated control panel design for Golden Tee Fore 2003 - 2005 games
- Spacer bracket to allow this trackball to be used in Golden Tee and Golden Tee Fore 2002 sold separately (95-1828-00)
- Highly specialized components provide the ultimate performance trackball for use with Golden Tee® Fore and PGA Tour machines



56-0100-11HL

3" Red Translucent Trackball Assembly with USB PS/@ Interface & Cable



- This trackball has the 12vdc bulb attached to the bottom for the backlit ball option
- Requires power supply part number 80-0001-00 (sold separately)

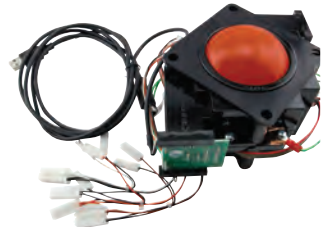

56-0300-10T12

3" RGB Illuminated Trackball with USB & PS/2 Output



- Add a dramatic effect and attract more attention to any game with this color changing trackball!
- 3" diameter diffused ball to provide uniform illumination of the ball



56-7000-24

3" Blue Translucent Trackball Assembly with USB PS/2 Interface & Cable 12V



- The SUZOHAPP USB/PS2 Trackball assemblies are trackballs that will connect to a computer without any external interface or power supply
- Allows the user to replace the existing mouse with a heavy-duty trackball for public access



56-0300-12T12

3" Diameter RGB LED Color Changing Trackball with TTL Output

- This trackball changes color while you play!
- Add a dramatic effect and attract more attention to any game
- 3" diameter diffused ball to provide uniform illumination of the ball
- 4 Ultra bright multi-color RGB LED's pre-programmed with 4 unique patterns and 8 different color combinations
- Patterns - Solid, Chase Pattern 1, Chase Pattern 2, Color Fade & Then Color Change
- Colors - Red, Green, Blue, Yellow, Orange, Purple, Light Blue, Light Purple
- Patterns & Colors easily selectable via switch on bottom of trackball

RBM-700-B

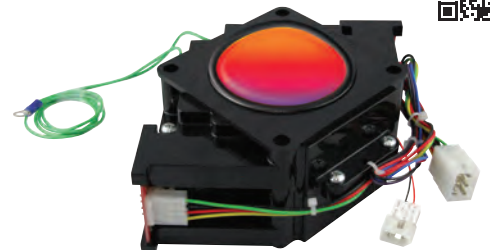

Target Based Components

45 Cal. SUZOHAPP Optical Gun Assembly, Red



- Utilizes the Type II gun halves
- New innovative optic PCB has innovative optic can holder that securely holds the optic in place and prevents breakage of optic legs due to shock
- Includes Durable Gun Tip Protector



SUZOHAPP

96-2300-10

45 Cal. SUZOHAPP Optical Gun Assembly, Blue



- Utilizes the Type II gun halves
- New innovative optic PCB has innovative optic can holder that securely holds the optic in place and prevents breakage of optic legs due to shock
- Includes Durable Gun Tip Protector



SUZOHAPP

96-2300-12

SUZOHAPP 29" Pump Action Shotgun, Orange



- Utilizes the Type II gun halves
- New innovative optic PCB has innovative optic can holder that securely holds the optic in place and prevents breakage of optic legs due to shock



CHERRY SUZOHAPP

96-0476-17

SUZOHAPP 29" Pump Action Shotgun, Green



- Utilizes the Type II gun halves
- New innovative optic PCB has innovative optic can holder that securely holds the optic in place and prevents breakage of optic legs due to shock



CHERRY SUZOHAPP

96-0476-13

Driving Controls

270° Soft Hoop Steering Wheel with Potentiometer



- New innovative "Sure-Grip" design gives better control and feel
- Molded durable black rubber hoop with checkered flag cap
- Ball bearing construction
- Potentiometer control or encoder PCB



SUZOHAPP

50-2838-00

270° Active Steering Wheel Assembly



- 270° wheel assembly fitted with a strong DC motor to provide realistic feel and feedback
- Requires signals from game board to operate
- Black Cap with checkered flag logo fitted as standard
- Not intended to connect to a PC



SUZOHAPP

50-0102-08

High-Low Speed Shifters



50-8017-00



50-8018-00

Part Number	Size
50-8017-00	2-Way Ultimate Joystick Bubbly Ball Knob - Pink
50-8018-00	2-Way Ultimate Joystick Bubbly Ball Knob - Blue

4-Speed Shifter Cruis'n USA, 20-10141



- 4-speed gated shifter
- Black insert molded shift knob
- 4 gold contact CHERRY microswitches
- Used on Cruisin' USA (sitdown cabinet) and NASCAR



50-8496-00

MIDWAY SUZOHAPP

Joysticks

4-Way Super Joystick with 43MM Bubbly Ball Knob



- Joystick used on Pac-Man
Chomp Mania by Namco



50-0111-00

SUZOHAPP

4-Way Ultimate Joystick with 43MM Clear Bubbly Ball Knob



- 4-way joystick can be configured for either metal or wood cabinet
- Microswitch



US

50-0099-04

SUZOHAPP

2-Way Ultimate Joystick with 43MM Bubbly Ball Knob



- Joystick used on Harpoon Lagoon by ICE
- ICE:HL2014BL
- Configurable for both metal and wood cabinets



ICE
SUZOHAPP

Part Number	Size
50-0101-00	2-Way Ultimate Joystick Bubbly Ball Knob - Pink
50-0105-00	2-Way Ultimate Joystick Bubbly Ball Knob - Blue

8-Way Competition Joystick with Microswitch

- Fits wood and metal control panels
- Spring return-to-center
- 8-way operation
- Microswitch reliability tested to 10,000,000 cycles
- .187" terminal Silver Contact Microswitch Standard
- Gold Contact Microswitch optional
- 8-way only
- Colors: red, blue, green, yellow and black



50-6070-100

50-6070-120

50-6070-130

50-6070-150

50-6070-160

Part Number	Description
50-6070-100	8-Way Competition Joystick with Microswitch - Red
50-6070-120	8-Way Competition Joystick with Microswitch - Blue
50-6070-130	8-Way Competition Joystick with Microswitch - Green
50-6070-150	8-Way Competition Joystick with Microswitch - Yellow
50-6070-160	8-Way Competition Joystick with Microswitch - Black



SUZOHAPP

Your Aftermarket Solutions Expert



TRANSACT Printers

- Industry leading, ultra-reliable TITO printer
- RS232 interface model
- One printer for all game types
- Drop-in compatibility with all current standard ticket printers - easy upgrades!
- Includes a standard 400 count ticket tray expandable to 600 tickets
- Patented Quick Disconnect Technology - allows you to easily remove the printer in one quick motion without powering-down the game or detaching cables - no reboot, more game uptime
- Ticketburst™ for reliable ticket presentation - TicketBurst™ technology prints and bursts each gaming voucher before presenting it to jams and eliminate player interference, ensuring maximum up time
- Rugged metal chassis provides robust grounding design for high ESD immunity and optimal field performance
- Extensive 8MB RAM and 4MB Flash for printer operations and end-user definables, such as graphics, fonts and international character sets

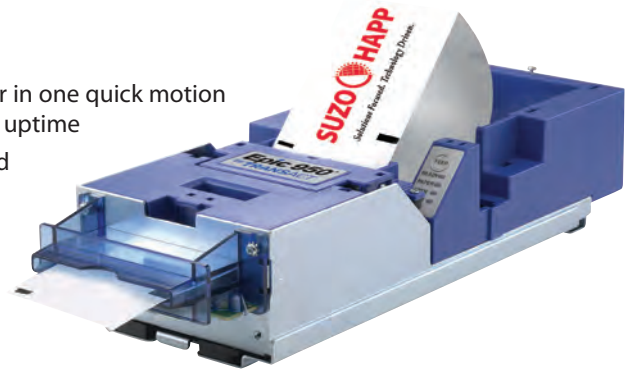

Part Number	Description
42-1034-00	Epic 950 RS232 TITO Printer
42-1047-00	Epic 950 Netplex/USB TITO Printer
42-1048-00	Epic 950 USB TITO Printer
42-1051-00	Epic 950 Netplex TITO Printer for Older IGT

TRANSACT
Technologies Incorporated

VISIONPRO

Vision Pro 6.2" Module for Bally Player Tracking with 5 Wire TD Design

- 1/2 VGA (640 by 240 resolution & 8 by 3 aspect ratio) color display with a LVDS Video and serial 5 wire touch serial interface
- Module Dimensions: 8.04(W) inches x 2.76(H) inches x 1.06(D) inches
- Screen active area: 5.83(W) inches x 2.12(H) inches
- Dot pitch: 3.05X10-3 (W) in x 3(R,G,B)(W) x 8.82X10-3(H) inches
- Resolution: 640 x 3(RGB)(W) x 240(H) dots
- LCD type TFT (RGB) vertical stripe active matrix
- Backlight: 21 each 40K hour LEDs
- Video Interface: 6bit LVDS



49-1201-00

Vision Pro 6.2" TFT 4 Wire Touch Panel & FPGA Board for IGT Advantage Tracking System

- Video timing translator board and accessories for converting video interface data between IGT® player tracking CPU and KOE's TX16D20* series displays
- Video Interface: 6bit CMOS
- Power supply: Display Driver (VDD) 3.3V; Backlight Driver (VBL) 5V

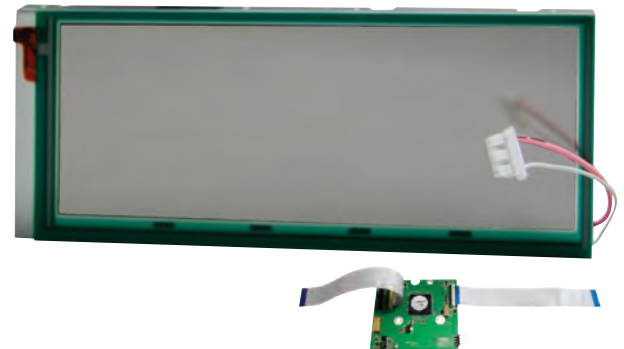

49-1228-00

XSt Card Readers

Partial Insertion Card Reader for Aristocrat and Konami, Track 1



- Bit/Strobe interface with StatGuard™ static protection
- Open slot architecture with front and rear card detects



70-1968-00

ARISTOCRAT KONAMI

Partial Insertion Magstripe Reader for Bally SDG



- RS-232 Interface with watchdog
- StatGuard™ static protection
- Front and rear card detects and reads multiple tracks



70-1972-00

Bally TECHNOLOGIES

Partial Insertion Magstripe Reader, Bally SDS



- Bit/Strobe interface
- StatGuard™ static protection
- Open slot architecture
- Front and rear card detects with jam proof card detect mechanism



70-1969-00

Bally TECHNOLOGIES

Partial Insertion Magstripe Reader for Bally ACSC



- TTL ASCII Interface with watchdog
- StatGuard™ static protection
- Direct optical front and rear card detects are standard



70-1973-00

Bally TECHNOLOGIES

Partial Insertion Magstripe Reader for IGT



- Bit/Strobe interface
- StatGuard™ static protection
- Open slot architecture with front and rear card detects
- Reads ISO track 1 or track 2



70-1971-00

igt

Partial Insertion Card Reader for Aristocrat and Konami, Track 2/Bally SDS



- Bit/Strobe interface with StatGuard™ static protection
- Open slot architecture with front and rear card detects



70-1974-00

ARISTOCRAT KONAMI

3M Touch Screens

Extended Durability for High Use Applications

MicroTouch™ ClearTek™ capacitive touch screens, manufactured by 3M Touch Systems, are the preferred touch solution for applications that require fast and accurate touch performance.

The flat capacitive profile sensor incorporates advanced construction and production techniques that result in a thin, sleek design which provides easy installation into flat panel displays and flat CRTs. The robust touch characteristics of ClearTek are attributed to its transparent overcoat, which significantly increases the physical durability of the surface by allowing it to resist scratches and abrasions. Popular applications include kiosks, ATM installations, point-of-sale, industrial equipment, gaming machines, and vending.

Features

- Transparent coating significantly increases durability by resisting scratches and abrasions
- Performance unaffected by everyday contaminants in the environment
- Accurate and fast touch response
- Narrow border for easy integration
- Connects to the new EX II electronics platform

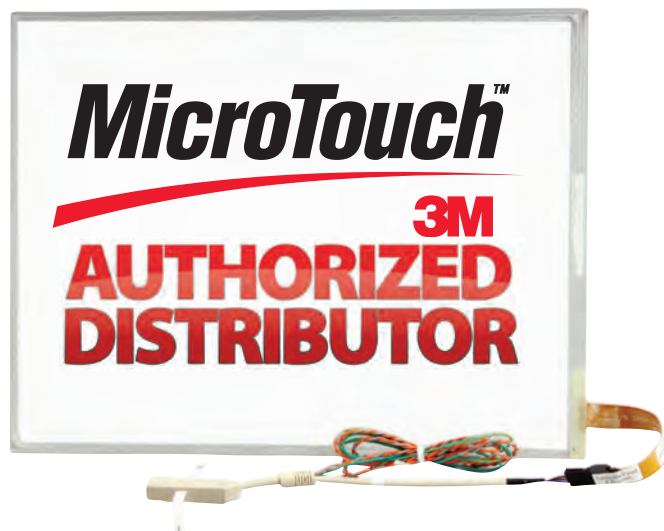

* Please contact your SUZOHAPP representative for 3M Touch Screen options

Increase Machine Play with a USB Charge 'N Play

Add **USB Charging capabilities** where your customers need it!

Give your customers a reason to:

✓ **Play Longer**

✓ **Stay Longer**

Install the USB Charge 'N Play Assembly

- Draw customers to machines and keep them playing longer while their mobile phones and other USB devices charge
- Designed to mount easily to wood or plastic cabinet
- Compatible with popular mobile devices
- Perfect for Bars, Casino Floors, Restaurants, Airports, and Lounges
- "Charge 'N Play" logo is backlit with a white LED for increased visibility (custom logos available)
- Maximum Output Current 2.1A DC (total)

Part Number	Description	Price Per ea.
96-1503-00	USB Charge 'N Play Assembly	\$30.00
95-1512-00	USB Charge 'N Play Single System Kit	\$75.00
95-1516-00	USB Charge 'N Play 2 System Kit	\$115.00
95-1521-00	USB Charge 'N Play 4 System Kit	\$195.00

Kits Include:	USB Charge 'N Play Single System Kit (P/N 95-1512-00)	USB Charge 'N Play 2 System Kit (P/N 95-1516-00)	USB Charge 'N Play 4 System Kit (P/N 95-1521-00)
USB Charge 'N Play Assembly	1	2	4
12V 5 amp 60 W Power Adapter	1	1	1
Universal Power Cord	1	1	1
2.5mm DC Extension Cable	1	2	4
4-Way Adapter Cable / Splitter	0	1	1
Hardware Kit & Instructions	1	2	4



Any USB device can be charged or powered with Charge 'N Play



95-1512-00
(only USB Charge 'N Play Assembly shown)

Why Buy SUZOHAPP CERTIFIED RECONDITIONED PRODUCTS?

HARD TO FIND **PRODUCTS**

Whether you need an obsolete power supply or an older LCD, SUZOHAPP can help you get your game back on the floor.

OEM REPLACEMENT **PARTS**

SUZOHAPP technicians use only the highest quality parts to refurbish each component.

PEACE OF MIND

Each Certified Reconditioned Product you purchase is repaired, updated, and repackaged to manufacturer's standards. It comes with our SUZOHAPP warranty.

Ask your Sales Representative about our **NEW Bill Validator & Printer Exchange Program!**



SUZOHAPP
Certified Reconditioned Product

SUZOHAPP is Your Trusted and Reliable Source for Ceronix LCDs & Monitors

Ceronix 32" LCD Monitor with Glass for Bluebird xD Metascreen; wide Viewing Angle

- 32 inch LCD with glass
- Wide 178 degree viewing angle available
- 16:9 aspect ratio
- Used on Bluebird xD Metascreen - Upper Display (top box)
- Replaces Kristel - LCD320-A34
- 4 year Ceronix warranty
- In-stock for immediate delivery

CPA6129



Ceronix 23" LCD Monitor with Glass for Blade Upright; Wide Viewing Angle; AC Current

- 23 inch LCD with glass
- Wide 178 degree viewing angle available
- 16:9 aspect ratio
- Runs on AC current
- Used on WMS Blade (CPU-NXT 3 Platform), Upright - Upper Display
- Replaces Kristel - LCD23-006
- Manufactured with premium grade components
- Manufactured by Ceronix in Auburn California
- 4 year Ceronix warranty

CPA6120



22" LCD Monitor with Glass; Wide viewing angle; for Konami Podium

- 22" LCD Monitor with safety glass
- Wide 178° viewing angle
- PMVA panel
- 16:10 aspect ratio
- Used on Konami Podium, Upright and Slant - Upper Display
- Replaces Konami - KGI530289

CPA6010



Display Audit Device

The H.264 RTSP (Real Time Streaming Protocol) Slot Display Device provides;

PROBLEM:

No independent Audit Record of Slot Display in current Slot Machine Software or Hardware configuration.

- The H.264 RTSP (Real Time Streaming Protocol) Slot Display Device provides;
- An independent Audit record of Slot Machine Game Display Events through Casino Surveillance.
- Real Time & Date stamp by Surveillance Time Server.
- A 2nd Independent onboard SD Display events record feature to accommodate any potential 3rd party tampering or surveillance network failure.
- Automatic Surveillance Alarm detection on Event Stream failure.
- Electronic Tamper Switch

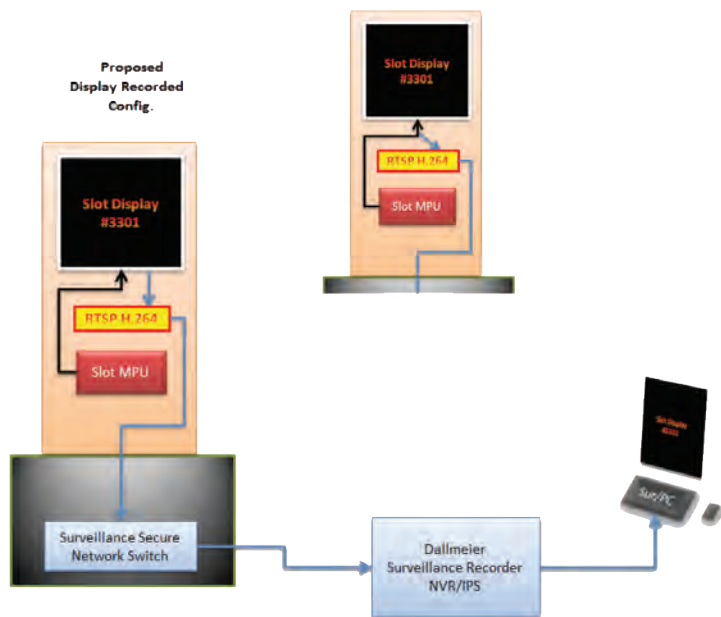

Display Event Streaming

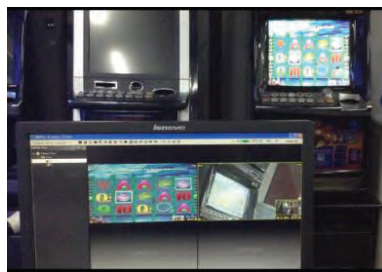

What This Device does

Configuration Event Capture

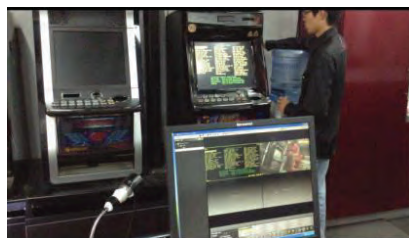

Uninterrupted Display Event Record & Recall

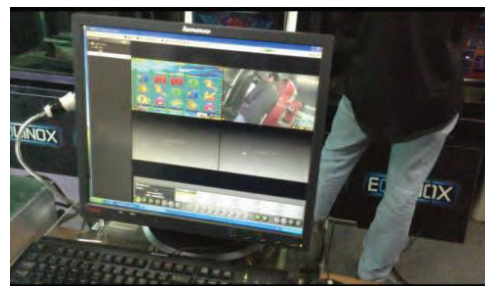

Assisting Camera Footage to validate disputes.

Buttons

Button Set for IGT Game King Bar Top Machine with 12V LED



- Rectangular and small square buttons with clear caps
- Fitted with 12v LED
- All buttons have white legends and black print except the "Change" button which has a red legend and white print
- Kit includes: 1 "DEAL/DRAW," 1 "BET ONE CREDIT," 1 "MAX BET," 1 "CASH OUT," 5 "HOLD/CANCEL," and 1 "CHANGE"



77-KIT-402

Poker 12V Illuminated Pushbutton Kit with Blue Halo Effect



- For IGT Bartop Poker Games - fits standard cabinet
- Ten Illuminated pushbuttons with legends, 12 volt LEDs and switches
- All legends are white with black lettering, except for "CHANGE" which is red with white lettering
- Kit includes: 1 "DEAL/DRAW," 1 "BET ONE CREDIT," 1 "MAX BET," 1 "CASH OUT," 5 "HOLD/CANCEL," and 1 "CHANGE"
- Includes In-line switches for Pancor connector



77-KIT-402-HALO

Cooling Fans

Cooling Fan with Heat Sink for ATI Radeon Pro 9800, 2-Pin Connector



- Replacement Fan for IGT graphics Card
- Direct replacement for fan and heat sink only



80-0006-67

CPU Cooling Fan



- 50mm x 50mm x 10mm
- 12V, 0.16A Ball bearing fan
- 2 wire
- Replacement for EC940301
- Used on Merit Megatouch and WMS Bluebird



80-0006-15

12VDC CPU Cooling Fan For Aristocrat



- 3-wire connection
- Size: 1.57" x 1.57" x 0.39" (40mm x 40mm x 10mm)
- 12vdc
- Ball Bearings
- Used on Aristocrat Mark VI Games



80-0006-62

3.15" x .98" 12VDC Power Supply Cooling Fan



- Rectangular and small square buttons with clear caps
- Fitted with 12v LED



80-0006-33

Cooling Fan, 1.57" x 1.57" x 0.79", 24VDC, with Connector



- Used in THE New IGT AVP power supply
- Used in Game King Machines
- Brushless fan ball bearing
- 40mm x 40mm x 20mm (1.57" x 1.57" x .79")
- 2 wires with connector
- Crosses to Innovative # BP402024H



70-1006-00

CPU Cooling Fan



- 70mm x 70mm x 10mm
- 12V, 0.23 A
- 4 wire connector



80-0006-72

LED Panels

Light Pro Edge-Lit LED Panel For IGT Denom Arrow Panels



- For use as side light in IGT Game King Round Top or Square Top, Game King 17" Upright Chop Top, and I Games
- Dramatically improves the lighting of the denom arrow panel providing improved color dispersion without shadows
- Includes LED edge-lit panel installed on rugged plastic housing for easy installation (graphic panel not included)
- Energy efficient panel only requires +12vdc 200 mA of power



LIGHTPRO

70-36588-00

Edge-Lit LED Panel For Aristocrat Viridian Belly Glass with Harness



- Complete kit, including harness
- Replaces bow-tie shaped cathode assembly and inverter
- Operates off game's DC voltage
- Installs in minutes
- 3 year warranty

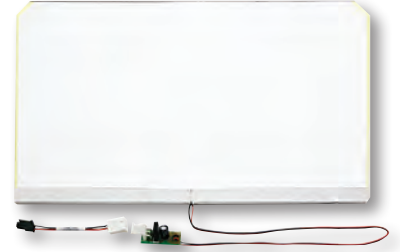

LIGHTPRO

70-36596-00-KIT

Light Pro Edge-Lit LED Panel for IGT Bartop and WMS BlueBird 1 Upright Lower Display



- Never Replace those #73 bulbs Again!!
- For use in IGT Bartop games and WMS Bluebird 1 lower display
- For IGT Bartop games as is - No Adapter Harness Needed
- For WMS Bluebird I Combo Top Box & Lower 3"x4" Illumination Panel (must also purchase 70-36590-00 & 70-0215-00)
- Dramatically improves the lighting of the game legend panel providing improved color dispersion without shadows



LIGHTPRO

70-36587-00

Light Pro Slant Top Edge-Lit Reflective LED Side Panel for IGT Game King Machines



- For IGT 17" & 19" slant top games side light
- Eliminates ballast and replaces the F4 lamp and entire fixture assembly
- Plastic mounting tray with 36" harness and cool white LEDs
- Improved color dispersion without shadows
- Direct replacement, plug-in convenience
- 5-8 year life span
- Low heat generation, 70% lower power consumption
- 3 Year Warranty on LED circuit



igt LIGHTPRO

70-36586-00

Light Pro Edge-Lit LED Panel For 17" or 19" IGT Game King Slant Top - Top Box



- Replaces the top box lighting in IGT 17" or 19" Game King Slant Top
- Dramatically improves the lighting of top box providing better color dispersion without shadows
- Eliminates the ballast and plugs into existing game harness
- Energy efficient panel only requires +24vdc 165 mA of power
- Eliminates the use of lamps, which frequently burn out



LIGHTPRO

70-36585-00

LED Edge-Lit Panel For Konami Belly Glass



- Replacement for all Konami Belly Glass currently edge-Lit with Cold-Cathode Lamps
- Powered by 12 volts directly, so there is NO inverter, ballast or adapter needed
- Just plug the power cord directly into the existing Molex connector that currently provides 12 volts of power to the CCFL inverter
- LED's will not break when the Drop Crews let the door drop and then slam it closed



LIGHTPRO

70-36599-00

Thank you for joining us!

