

6. General Specifications:

Currency and Protocol: See Software Description Document

Electrical Specification:

| Voltage | Max. Operating Current | Max. Current |
|---------|------------------------|--------------|
| 24 V DC | 0.5 A | 1.0 A |

Use only current limiting CSA or UL approved Power Supply.

Operating Temperature: -0 to +50 Degrees Celsius

Weight: 4.2 kg (Without Cassette)

Weight of Cassette: 1.9 kg

Features: Multi-Width Validating Head
Bracket for Optional Lock for the Cassette
End Switch for the Cassette and Cassette Lock
Bezel

Items Enclosed: MFL Bill Validator
User Guide
Software Description
JAE Connector Kit OPT-MKFL-JAE
Lock Installation Kit OPT-MKFL-FLH

Optional: Sensor Box Extractor OPT-HW-FT01

Front Load Bill Validator

MFL-0594

The Part Number on the Label includes Hardware Part Number and Software Part Number.

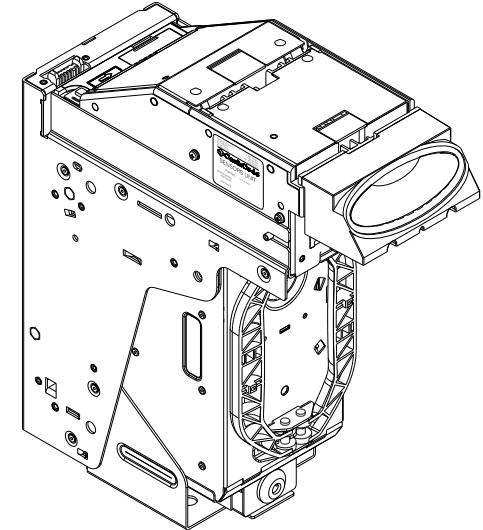
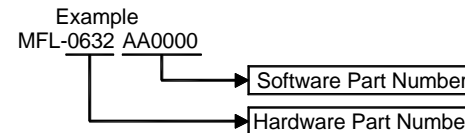

1. Assembly Contents:

| Unit | Part No. | Description |
|-----------------|------------------------|---|
| Validating Head | MFLV-9013 | With Multi-Width Centering Mechanism |
| Sense -A- Click | FLS-1707U FLS-1707L | Sense-A-Click Sensor Packs |
| Bezel | MFLB-5901 | Bezel, Custom |
| Housing | FLH-0810 | 600, Lock Bracket, Cassette and Lock Switches |
| Power Interface | FLP-9028 | 24 V DC, RS-232 |

2. DIP Switch Setting:

DIP switches may be accessed by removing the Validating Head and opening the transparent cover at the rear. See Software Description for correct denominations and settings.

| SW No.1 | ON State | OFF State | Default |
|---------|--------------------|---------------------|---------|
| SW 1.1 | Bill Type 1 Enable | Bill Type 1 Disable | ON |
| SW 1.2 | Bill Type 2 Enable | Bill Type 2 Disable | ON |
| SW 1.3 | Bill Type 3 Enable | Bill Type 3 Disable | ON |
| SW 1.4 | Bill Type 4 Enable | Bill Type 4 Disable | ON |
| SW 1.5 | Bill Type 5 Enable | Bill Type 5 Disable | ON |
| SW 1.6 | Bill Type 6 Enable | Bill Type 6 Disable | ON |
| SW 1.7 | Bill Type 7 Enable | Bill Type 7 Disable | ON |
| SW 1.8 | Bill Type 8 Enable | Bill Type 8 Disable | ON |

| SW No.2 | ON State | OFF State | Default |
|---------|----------|--------------------|---------|
| SW 2.1 | Four Way | One Way | ON |
| SW 2.2 | Reserved | Reserved | ON |
| SW 2.3 | Reserved | Reserved | ON |
| SW 2.4 | Service | Host Communication | OFF |

3. Interface Connector Pinout:

Mating Connector:

Socket DR-12-2SC-FO (JAE)

Contact DR-SC20-1-7000 (JAE)



| Terminal | Circuit |
|----------|----------|
| 1 | PWR GND |
| 2 | M – RES |
| 3 | |
| 4 | COMM GND |
| 5 | |
| 6 | |
| 7 | +24 V DC |
| 8 | TxD |
| 9 | RxD |
| 10 | |
| 11 | |
| 12 | |

4. Diagnostics:

Chart below lists the validator malfunctions, as indicated by the flashing bezel light:

| No. of Consecutive Flashes | Malfunction |
|----------------------------|--|
| 1 Red/ Pause | Cassette is out of position |
| 2 Red/ Pause | Wrong Sense-A-Click type or Sense-A-Click failed |
| 3 Red/ Pause | Cassette is full |
| 4 Red/ Pause | Jam in the Cassette (Stacking Motor cannot stack the bill) |
| 5 Red/ Pause | Failure of Capacitance Sensors |
| 6 Red/ Pause | Failure of Optical Sensors |
| 7 Red/ Pause | Failure of Magnetic Sensors |
| 8 Red/ Pause | Transport Motor failure |
| 9 Red/ Pause | Speed of Transport Motor is fast |
| 10 Red/ Pause | Failure of Aligning Motor or Aligning Sensor |
| 11 Red/ Pause | Bill Pathway is not empty (bill is jammed) |
| 12 Red/ Pause | Jam at the entry of the Cashbox and credit is not issued |
| 13 Red/ Pause | Transport Motor overload |
| 1 Green/ Red | COM Port CRC error |
| 2 Green/ Red | Internal CRC error |
| 3 Green/ Red | Improper Memory Stick |
| 4 Green/ Red | Memory Stick is absent |
| 5 Green/ Red | Improper type of Memory Stick |
| 6 Green/ Red | Download error |

5. Bezel Installation:

1. Switch power off or disconnect power-interface cable.
2. Do not touch electrical connectors or cables without using proper electrostatic protection.

