

6. General Specifications:

Currency and Protocol: See Software Description Document

Electrical Specification:

Voltage	Max. Operating Current	Max. Current
24 V DC	0.5 A	1.0 A

Use only current limiting CSA or UL approved Power Supply.

Operating Temperature: -0 to +50 Degrees Celsius

Weight: 4.2 kg (Without Cassette)

Weight of Cassette: 1.9 kg

Features: Multi-Width Validating Head
Bracket for Optional Lock for the Cassette
End Switch for the Cassette and Cassette Lock Bezel

Items Enclosed: MFL Bill Validator
User Guide
Software Description
JAE Connector Kit OPT-MKFL-JAE
Lock Installation Kit OPT-MKFL-FLH

Optional: Sensor Box Extractor OPT-HW-FT01

Front Load Bill Validator

MFL-0519

The Part Number on the Label includes Hardware Part Number and Software Part Number.

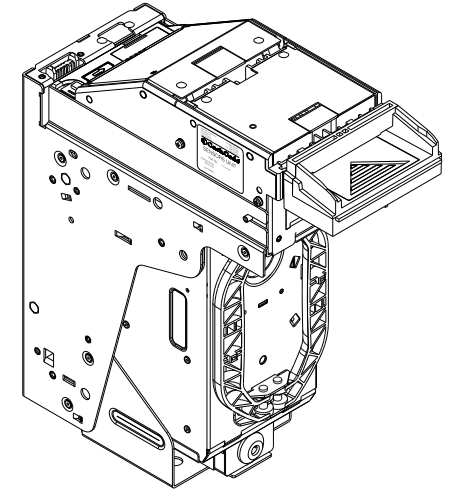
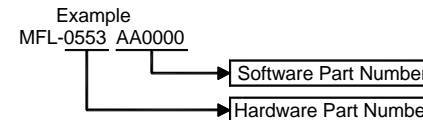

1. Assembly Contents:

Unit	Part No.	Description
Validating Head	MFLV-9013	With Multi-Width Centering Mechanism
Sense -A-Click	FLS-1707U FLS-1707L	Sense-A-Click Sensor Packs
Bezel	MFLB-9064	Bezel, Custom
Housing	FLH-0810	600, Lock Bracket, Cassette and Lock Switches
Power Interface	FLP-9028	24 V DC, RS-232

2. DIP Switch Setting:

DIP switches may be accessed by removing the Validating Head and opening the transparent cover at the rear. See Software Description for correct denominations and settings.

SW No.1	ON State	OFF State	Default
SW 1.1	Bill Type 1 Enable	Bill Type 1 Disable	ON
SW 1.2	Bill Type 2 Enable	Bill Type 2 Disable	ON
SW 1.3	Bill Type 3 Enable	Bill Type 3 Disable	ON
SW 1.4	Bill Type 4 Enable	Bill Type 4 Disable	ON
SW 1.5	Bill Type 5 Enable	Bill Type 5 Disable	ON
SW 1.6	Bill Type 6 Enable	Bill Type 6 Disable	ON
SW 1.7	Bill Type 7 Enable	Bill Type 7 Disable	ON
SW 1.8	Bill Type 8 Enable	Bill Type 8 Disable	ON

SW No.2	ON State	OFF State	Default
SW 2.1	Four Way	One Way	ON
SW 2.2	Reserved	Reserved	ON
SW 2.3	Reserved	Reserved	ON
SW 2.4	Service	Host Communication	OFF

3. Interface Connector Pinout:

Mating Connector:

Socket DR-12-2SC-FO (JAE)

Contact DR-SC20-1-7000 (JAE)

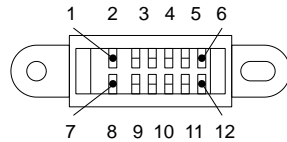

Terminal	Circuit
1	PWR GND
2	M – RES
3	
4	COMM GND
5	
6	
7	+24 V DC
8	TxD
9	RxD
10	
11	
12	

4. Diagnostics:

Chart below lists the validator malfunctions, as indicated by the flashing bezel light:

No. of Consecutive Flashes	Malfunction
1 Red/ Pause	Cassette is out of position
2 Red/ Pause	Wrong Sense-A-Click type or Sense-A-Click failed
3 Red/ Pause	Cassette is full
4 Red/ Pause	Jam in the Cassette (Stacking Motor cannot stack the bill)
5 Red/ Pause	Failure of Capacitance Sensors
6 Red/ Pause	Failure of Optical Sensors
7 Red/ Pause	Failure of Magnetic Sensors
8 Red/ Pause	Transport Motor failure
9 Red/ Pause	Speed of Transport Motor is fast
10 Red/ Pause	Failure of Aligning Motor or Aligning Sensor
11 Red/ Pause	Bill Pathway is not empty (bill is jammed)
12 Red/ Pause	Jam at the entry of the Cashbox and credit is not issued
13 Red/ Pause	Transport Motor overload
1 Green/ Red	COM Port CRC error
2 Green/ Red	Internal CRC error
3 Green/ Red	Improper Memory Stick
4 Green/ Red	Memory Stick is absent
5 Green/ Red	Improper type of Memory Stick
6 Green/ Red	Download error

5. Bezel Installation:

1. Switch power off or disconnect power-interface cable.
2. Do not touch electrical connectors or cables without using proper electrostatic protection.

